

TDS20065 (CoolMasterNet) **Universal HVAC Master on LAN** **Quick Installation Guide**



TELETASK
trendsetter in home automation

Warning

Read these **Safety Precautions** carefully to ensure correct installation.

This manual classifies precautions into **WARNING** and **CAUTION**.



Failure to follow WARNING is very likely to result in such grave consequences as death or serious injury

WARNING

- Only qualified personnel must carry out the installation work.
- Ask your dealer or technical representative to install the unit.
- Any deficiency caused by your own installation may result in an electric shock or fire.
- All electrical work must be performed by a licensed technician, according to local regulations and in accordance with the instructions in the installation manual.
- Any lack of electric circuit or any deficiency caused by installation may result in an electric shock or fire. Do not relocate or reinstall the TDS20065 by yourself.
- Any deficiency caused by your own re-installation may result in an electric shock or fire.
- Make sure that all wiring is secured, that specified wires are used and that no external forces act on terminal connections or wires. Improper wiring connections or installation may produce heat and result in fire.
- Before touching electrical parts, turn off the unit.
- To dispose of this product, consult your dealer.

Caution



Failure to follow CAUTION may result in serious injury or property damage, and in certain circumstances, may result in a grave onsequence.

CAUTION

- Do not allow children to play with the TDS20065 and supervise them not to get access to the appliance.
- TDS20065 is not to be used by persons with reduced physical, sensory or mental capabilities, or lack of experience and knowledge.
- Do not disassemble, modify or repair the TDS20065.
- Any deficiency caused by your modification or repair may result in an electric shock or fire.
- Never let the **TDS20065** to get wet.
- Water can cause damage to the **TDS20065**, and may cause an electric shock or fire.
- Do not use flammable materials (e.g. hairspray or insecticide) near the **TDS20065**.
- Do not clean the **TDS20065** with organic solvents such as paint thinner. The use of organic solvents may cause cracking, damaging the **TDS20065**, causing electrical shock or fire.
- **Do not apply AC110V or AC220V to the TDS20065 The maximum voltage that can be applied to the unit directly is 24V DC.**
- If damaged **TDS20065** can generate heat and cause a fire.

Caution



Failure to follow CAUTION may result in serious injury or property damage, and in certain circumstances, may result in a grave consequence.

DO NOT INSTALL THE COOLMASTERNET IN THE FOLLOWING LOCATIONS:

- a) Where a mineral oil mist or oil spray or vapor is produced, for example, in a kitchen. Plastic parts may deteriorate and fall off or result in water leakage.
- b) Where corrosive gas, such as sulfurous acid gas, is produced.
- c) Near machinery emitting electromagnetic waves. Electromagnetic waves may disturb the operation of the **TDS20065** and cause the unit to malfunction.
- d) Where flammable gas may leak, where there is carbon fiber or ignitable dust suspensions in the air, or where volatile flammable such as thinner or gasoline are handle Operating the **TDS20065** in such conditions can cause a fire. High
- e) temperature area or directly flamed point. Heating and/or fire can occur.
- f) Moist area, where there is exposure to water. If water enters the inside of the **TDS20065** it may cause electric shock and electrical components may fail.

Contents

Warning	2
Caution	3
Contents	5
What's in the box	6
CoolMasterNet	7
Preconfigured CoolMasterNet	8
HVAC Line configuration	9

L1 HVAC Daikin VRV (Yanmar)	10
HVAC Daikin Non-VRV	11
HVAC Mitsubishi Electric VRF (Trane)	12
HVAC Mitsubishi Electric Non-VRF	13
HVAC Panasonic/Sanyo VRF	14
HVAC Toshiba VRF (Carrier)	15
HVAC Hitachi VRF (Hisense, York, JCI)	16
HVAC Haier VRF (York, Trane, CIAC)	17

L7 HVAC Mitsubishi Heavy VRF	18
HVAC LG VRF (Arcelik)	19
HVAC AUX VRF (Rheem, IGC)	20

L7 HVAC Gree/GMV4 VRF (Lennox, Tica, Innovair)	21
HVAC Midea VRF (Intensity, Trane, Carrier, Lennox, Comfort Star, Kentatsu, Electra, Voltas, Bryant, Maxxa, Ecox, Clivet, Bosch, SystemAir, Lessar, NED, Dantex, Sanys)	22
HVAC Samsung VRF (Trane)	23
HVAC Chigo VRF (Rheem, Sharp)	24
HVAC Blue Star VRF	25

L8 HVAC Gree GMV5, GMV6 (Gree) VRF (Fujitherma, Aermec, Tosot, Tadiran, Energolux, AlpicAir, Cooper&Hunter, Pioneer, Lennox, Air Con)	26
HVAC Fujitsu VRF (Rheem, Atlantic)	27

How to change the brand of a specific line	28
CoolMasterNet installation complete	29
Home Automation, BMS & CoolRemote App	30
Power Supply	31
All On/Off operation by external signal	32
Mounting on DIN rail	33
Mounting on a wall	34
Online documentation and Support	35

What's in the box

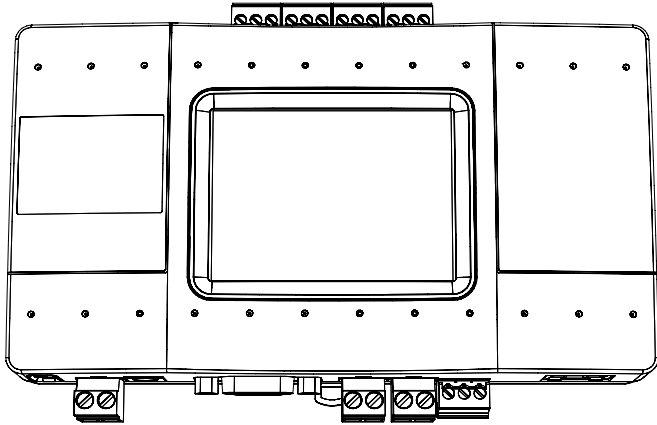

TDS20065 Universal HVAC
Master on LAN Interface

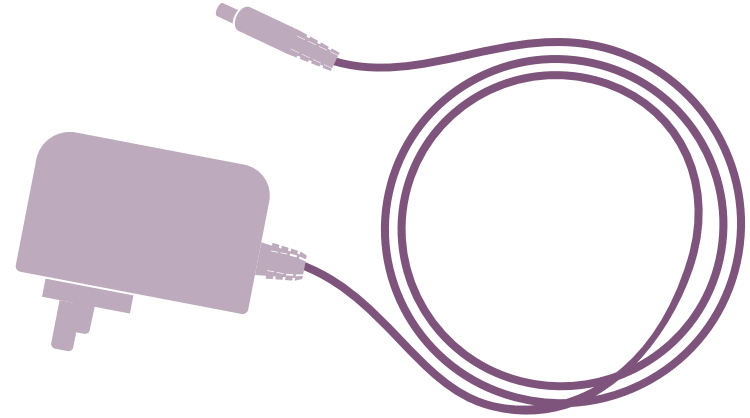

AC Power supply adapter
100V-240V 50/60hz to 12V



TDS15200
Airco interface license

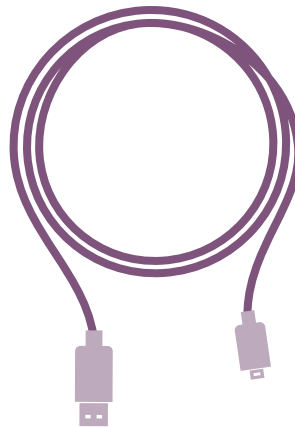

1 USB-Mini USB
cable

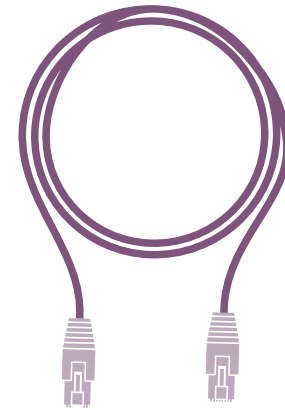

1 Ethernet
cable

TDS20065 Universele HVAC Master op LAN

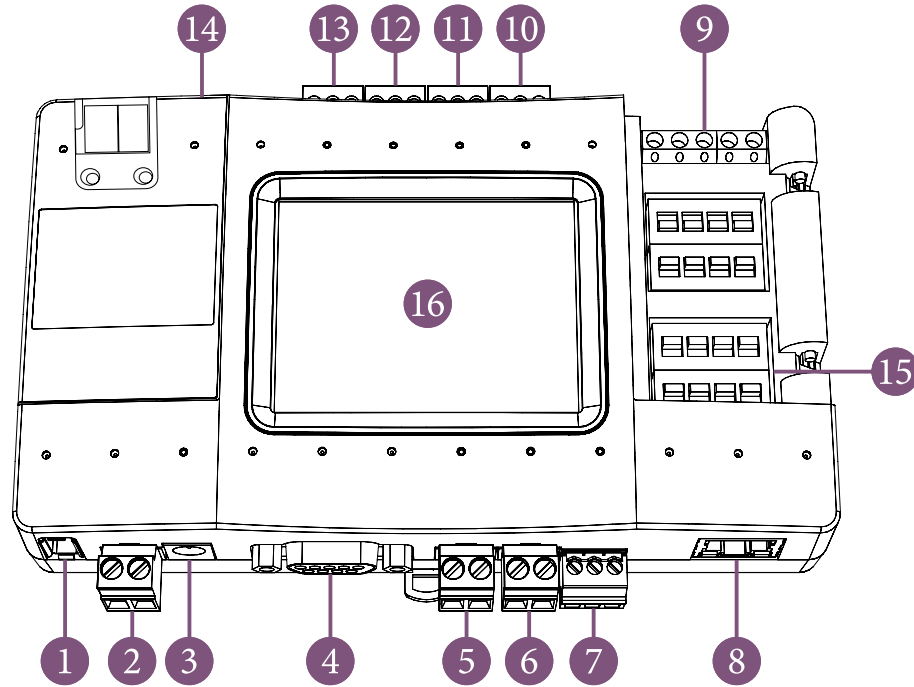

1 L8 - HVAC Line 8 (USB Host)

2 Power

3 Power Plug

4 RS232 Port

5 L1 - HVAC Line 1

6 L2 - HVAC Line 2

7 L3 - RS485

8 Ethernet Port

9 GPIOs

10 L7 - HVAC Line 7

11 L6 - HVAC Line 6

12 L5 - HVAC Line 5

13 L4 - HVAC Line 4

14 USB Device Port

15 DIP Switches P, Q, R, S

16 LCD Touch Screen

Preconfigured TDS20065

Type label

This label uniquely identifies the manufacturer's configuration of

TDS20065. Located on the back of the enclosure.

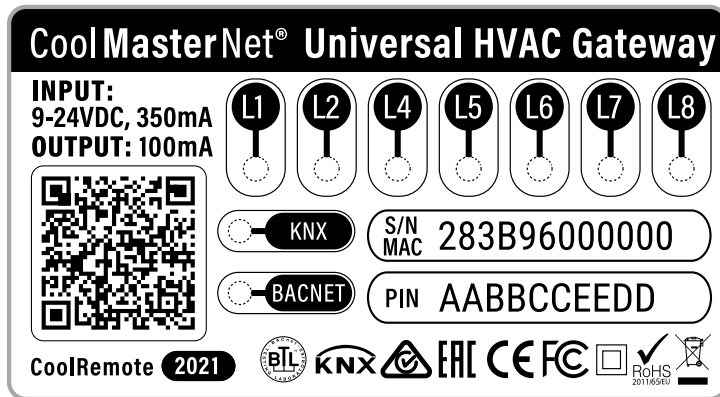

Type label with Configuration sticker

A preconfigured label example:

configured for LG on L7

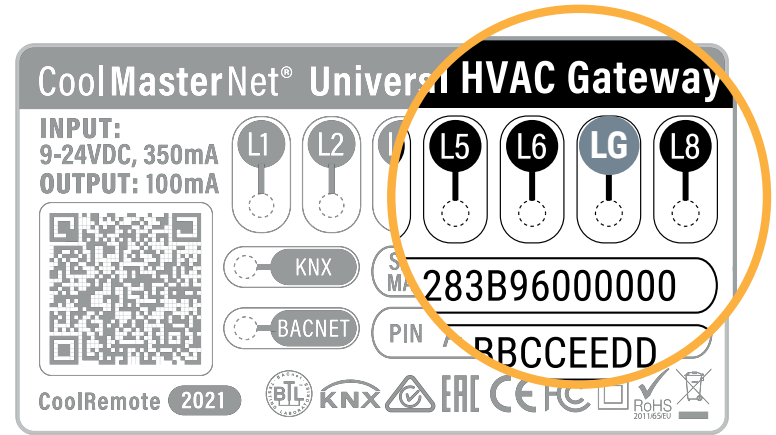

HVAC Line con igituration

DK Daikin

HT Hitachi

HA Haier

ME Mitsubishi Electric

TO Toshiba

PN Panasonic

FJ Fujitsu

LG LG

SM Samsung

MD Midea

CG Chigo

GR Gree

AU AUX

BS Blue Star

MH Mitsubishi Heavy

HVAC Daikin VRV

1 HVAC Communication Terminals

HVAC outdoor connection



* For Heat Recovery systems the connection is at outdoor units only.

* Polarity is not required on the HVAC communication line.

** Centralized (groupaddress required).

2 Connecting to the line plug

Secure the cables in the L1 line plug.

3 Plugging to the TDS20065

Insert the plug in to the TDS20065 L1 socket.

4 Check DIP Switches are set correctly

Dip switches setup for VRV HVAC system on L1.

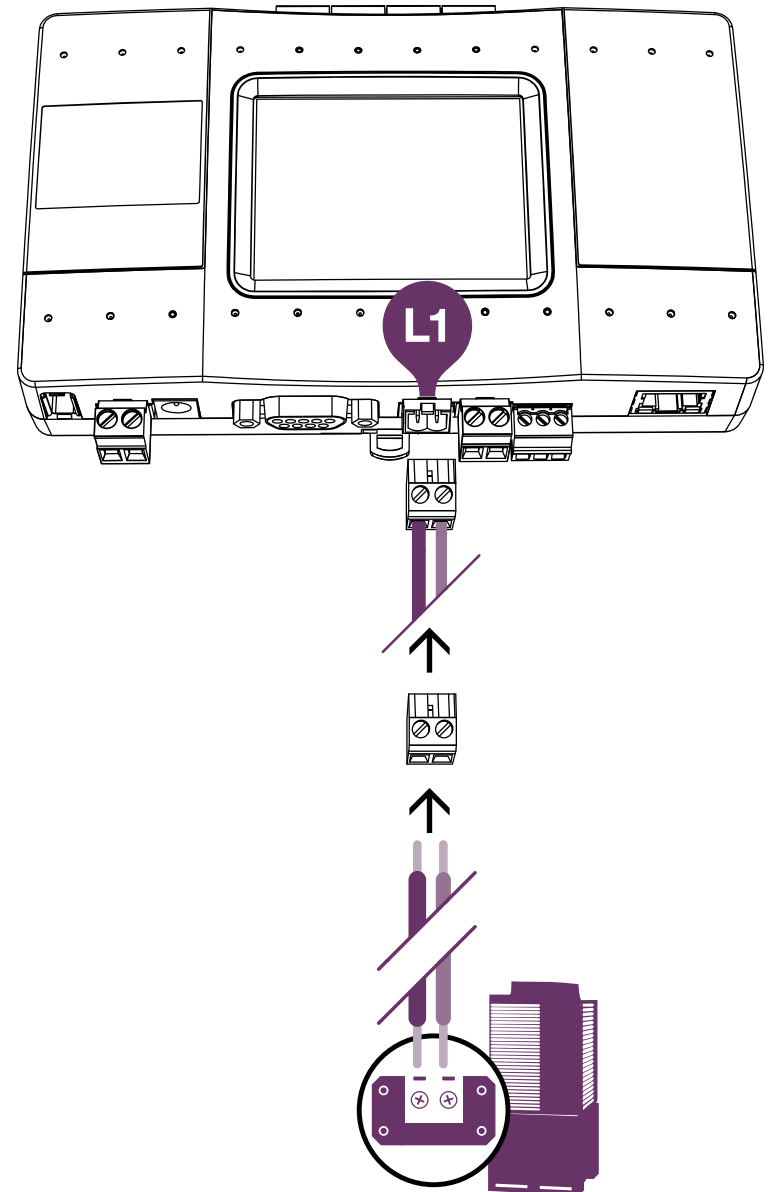
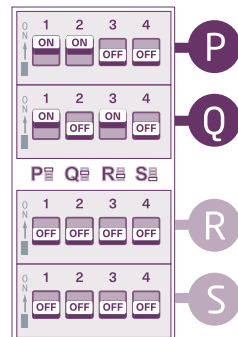
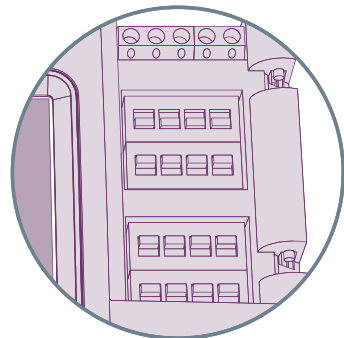

Daikin HVAC Terminal

HVAC Daikin Non-VRV



Changing the dip switches **S**, while DC voltage is present on L1, may damage the CoolMasterNet.

For Daikin Non-VRV equipment, DC voltage supply by CoolMasterNet might be required for proper operation.

! Make sure CoolMasterNet is disconnected from power and HVAC line.

1 HVAC Communication Terminals

HVAC Indoor connection



* Polarity is not required on the HVAC communication line.

** Centralized (group) address required.

- 2 Measure DC voltage on HVAC comm. line L1
- 3 If no **14-16V DC voltage** change the dip switches as shown below:
Go to settings → Go to HVAC lines → Go to L1 → Go to DC Out turn on
- 4 Turn ON the power for TDS20065 (CoolMasterNet) and connect it to HVAC line.
- 5 Connect to the communication terminals on the HVAC equipment and secure the cables in the L1 line plug.
- 6 Insert the plug in to CoolMasterNet L1 socket.

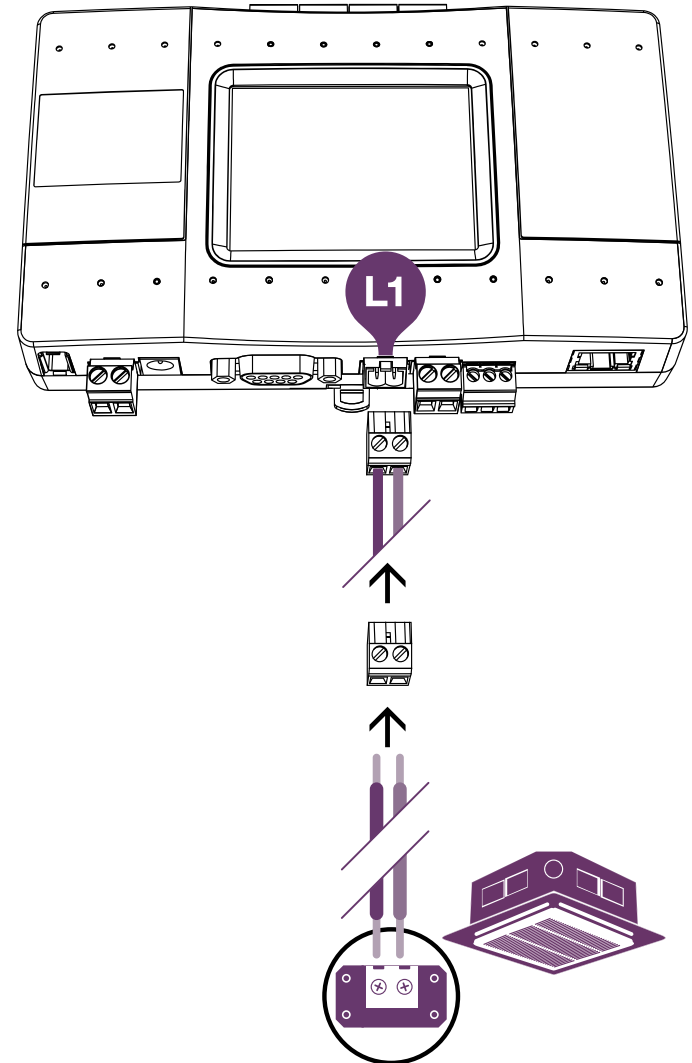
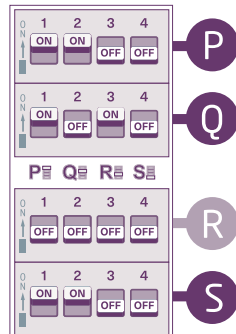
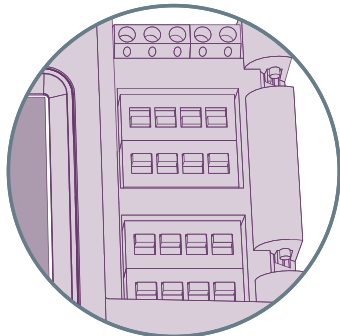

Daikin Non-VRV HVAC Terminal

HVAC Mitsubishi Electric VRF

① HVAC Communication Terminals

HVAC outdoor connection



- * For Heat Recovery systems the connection is at outdoor units only.
- * Polarity is not required on the HVAC communication line.

② Connecting to the line plug

Secure the cables in the L1 line plug.

③ Plugging to the CoolMasterNet

Insert the plug in to the TDS20065 L1 socket.

④ Check DIP Switches are set correctly

Dip switches setup for VRF HVAC system on L1.

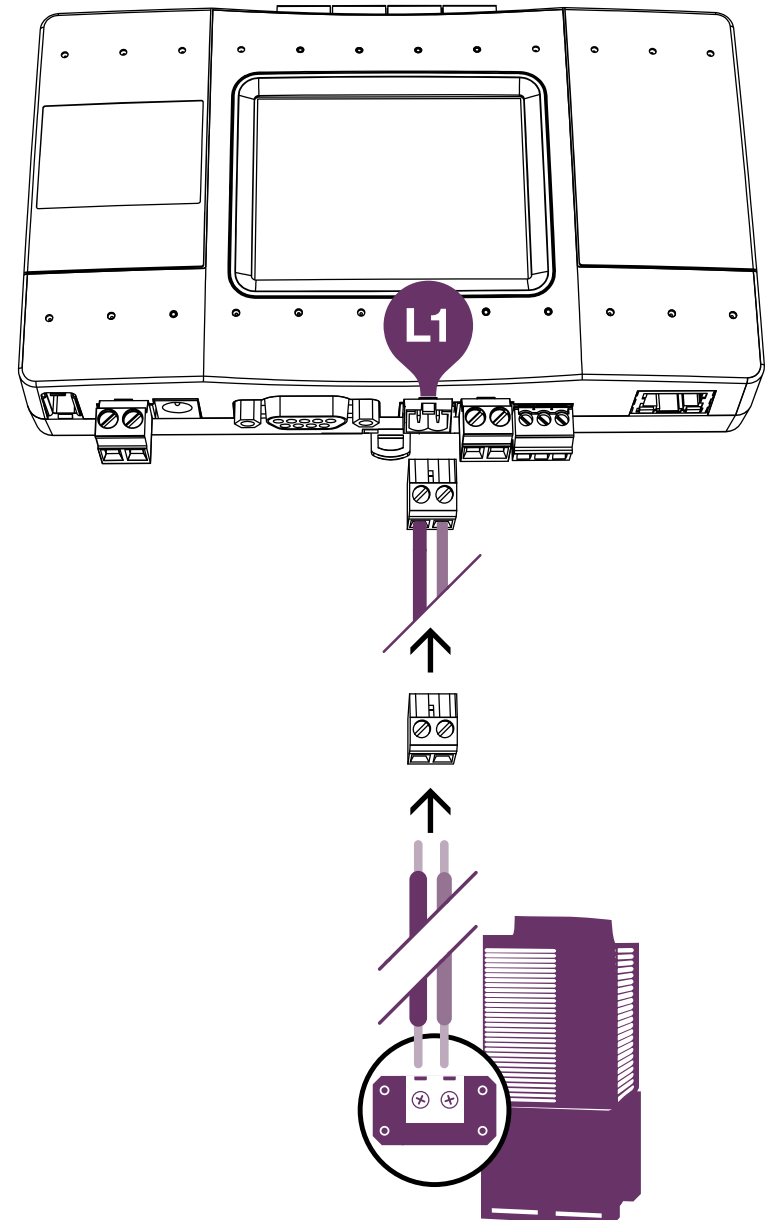
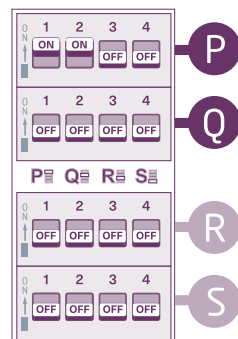
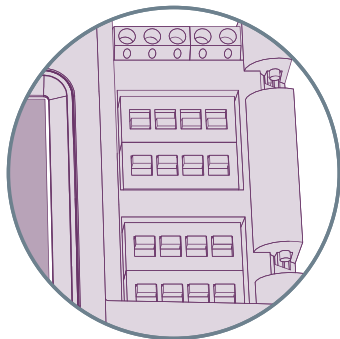

Mitsubishi Electric HVAC Terminal

HVAC Mitsubishi Electric Non-VRF



Changing the dip switches **S**, while DC voltage is present on L1, may damage the CoolMasterNet.

For Mitsubishi Electric Non-VRF equipment, DC voltage supply by CoolMasterNet might be required for proper operation.

! Make sure CoolMasterNet is disconnected from power and HVAC line.

1 HVAC Communication Terminals

HVAC Indoor connection



* Polarity is not required on the HVAC communication line.

2 Measure DC voltage on HVAC comm. line L1

3 If no **28-30V DC voltage** change the dip switches as shown below:

Go to settings → Go to HVAC lines → Go to L1 → Go to DC Out turn on



4 Turn **ON** the power for TDS20065 and connect it to HVAC line.

5 Connect to the communication terminals on the HVAC equipment and secure the cables in the L1 line plug.

6 Insert the plug in to CoolMasterNet L1 socket.

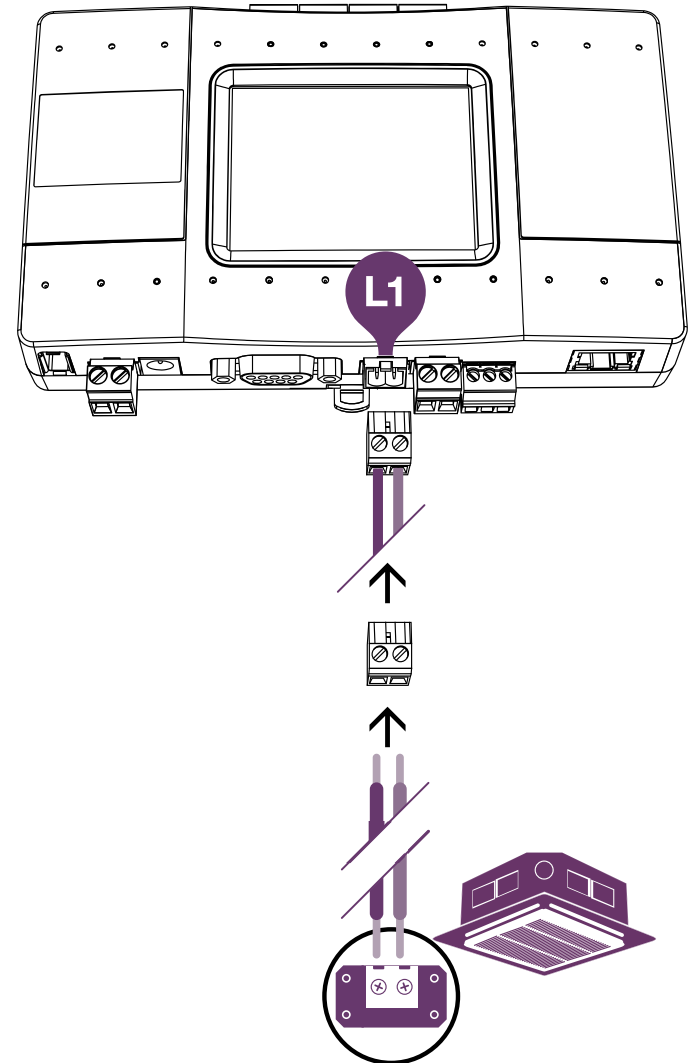
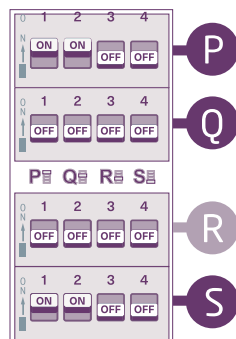
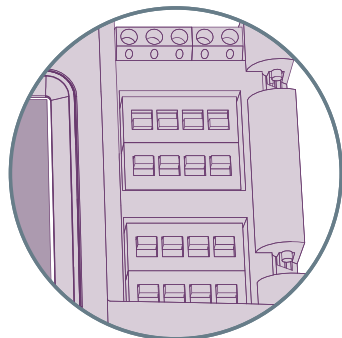

Mitsubishi Non-VRF HVAC Terminal

HVAC Panasonic/Sanyo VRF

① HVAC Communication Terminals

HVAC outdoor connection

U1		PN	Panasonic / Sanyo Max. 64 indoor units
U2			

- * For Heat Recovery systems the connection is at outdoor units only.
- * Polarity is not required on the HVAC communication line.

② Connecting to the line plug

Secure the cables in the L1 line plug.

③ Plugging to the TDS20065

Insert the plug in to the TDS20065 L1 socket.

④ Check DIP Switches are set correctly

Dip switches setup for VRF HVAC system on L1.

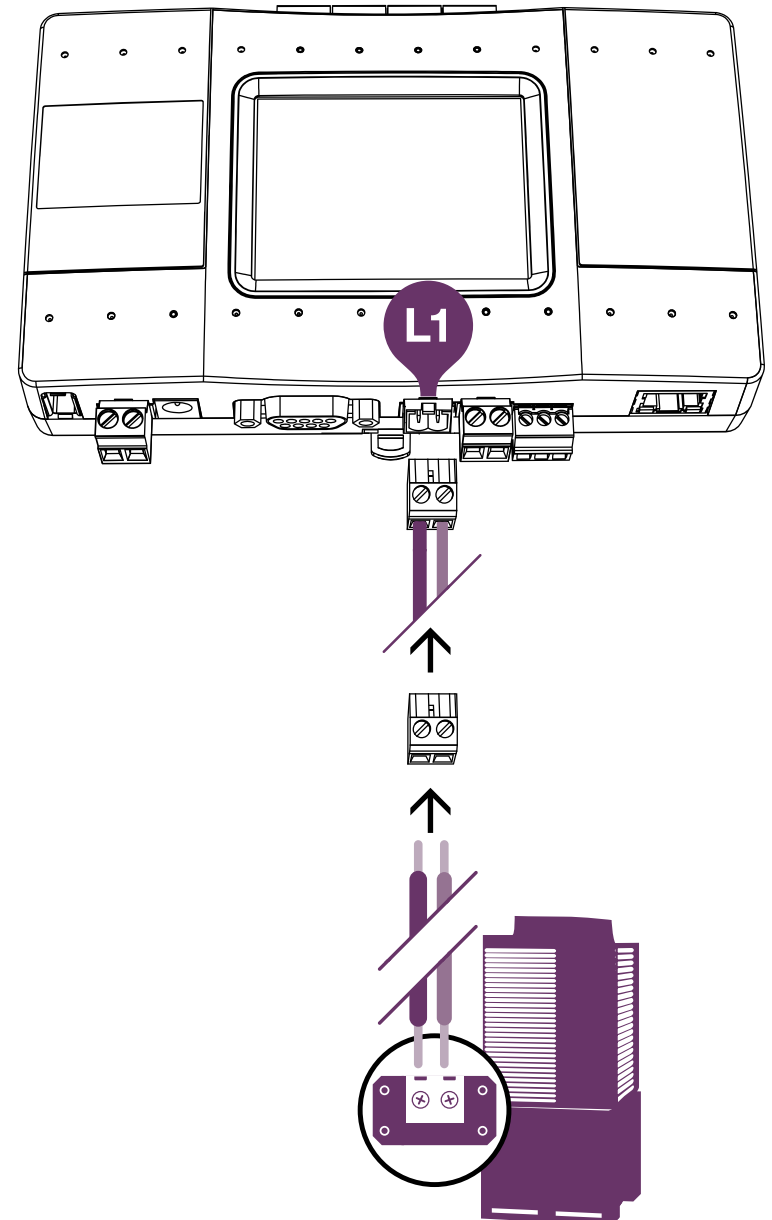
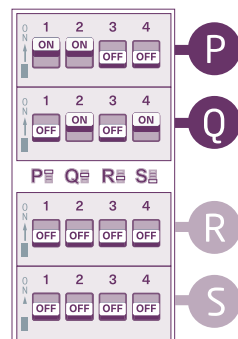
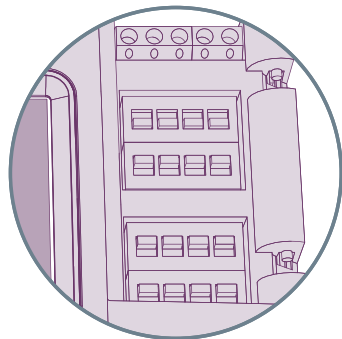

Panasonic / Sanyo HVAC Terminal

HVAC Toshiba VRF

1 HVAC Communication Terminals

HVAC outdoor connection



- * For Heat Recovery systems the connection is at outdoor units only.
- * Polarity is not required on the HVAC communication line.

2 Connecting to the line plug

Secure the cables in the L1 line plug.

3 Plugging to the TDS20065

Insert the plug in to the TDS20065 L1 socket.

4 Check DIP Switches are set correctly

Dip switches setup for VRF HVAC system on L1.

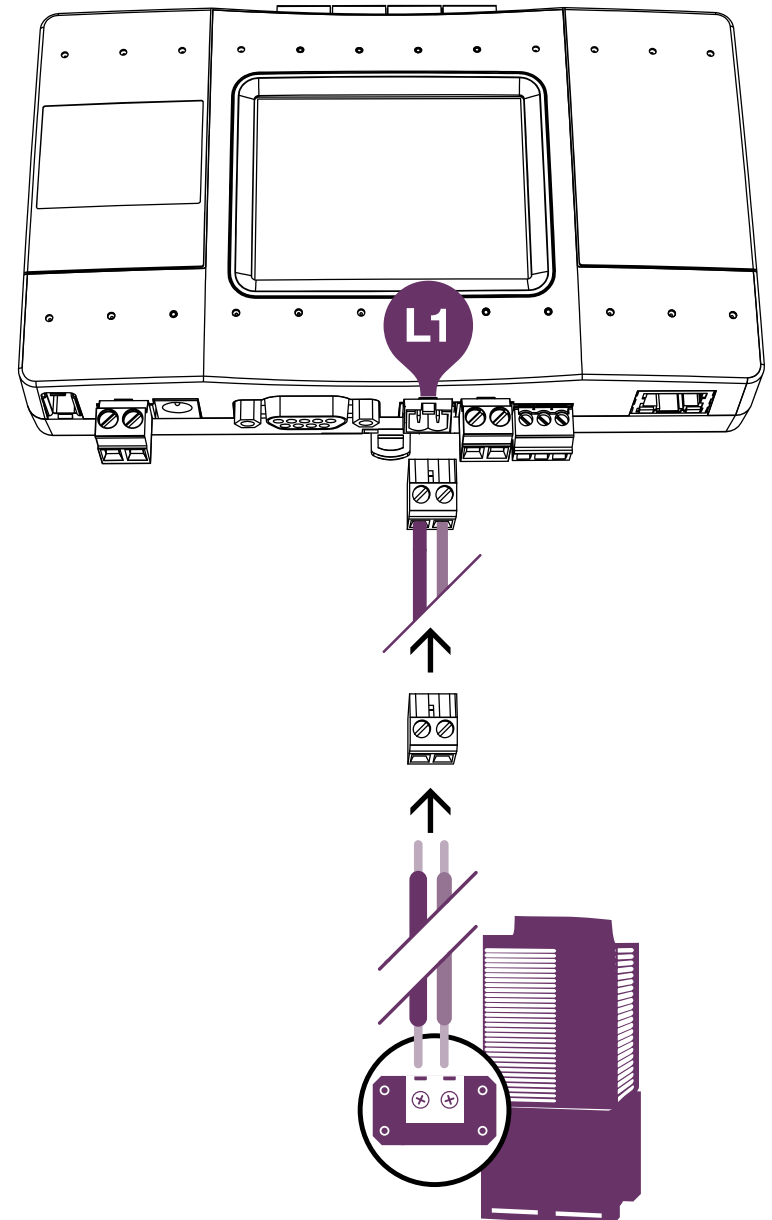
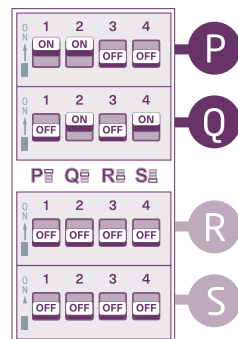
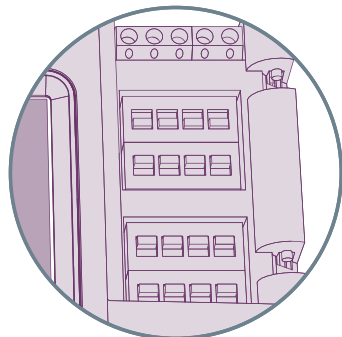

HVAC Hitachi VRF

① HVAC Communication Terminals

HVAC outdoor connection



* For Heat Recovery systems the connection is at outdoor units only.

* Polarity is not required on the HVAC communication line.

② Connecting to the line plug

Secure the cables in the L1 line plug.

③ Plugging to the TDS20065

Insert the plug in to the TDS20065 L1 socket.

④ Check DIP Switches are set correctly

Dip switches setup for VRF HVAC system on L1.

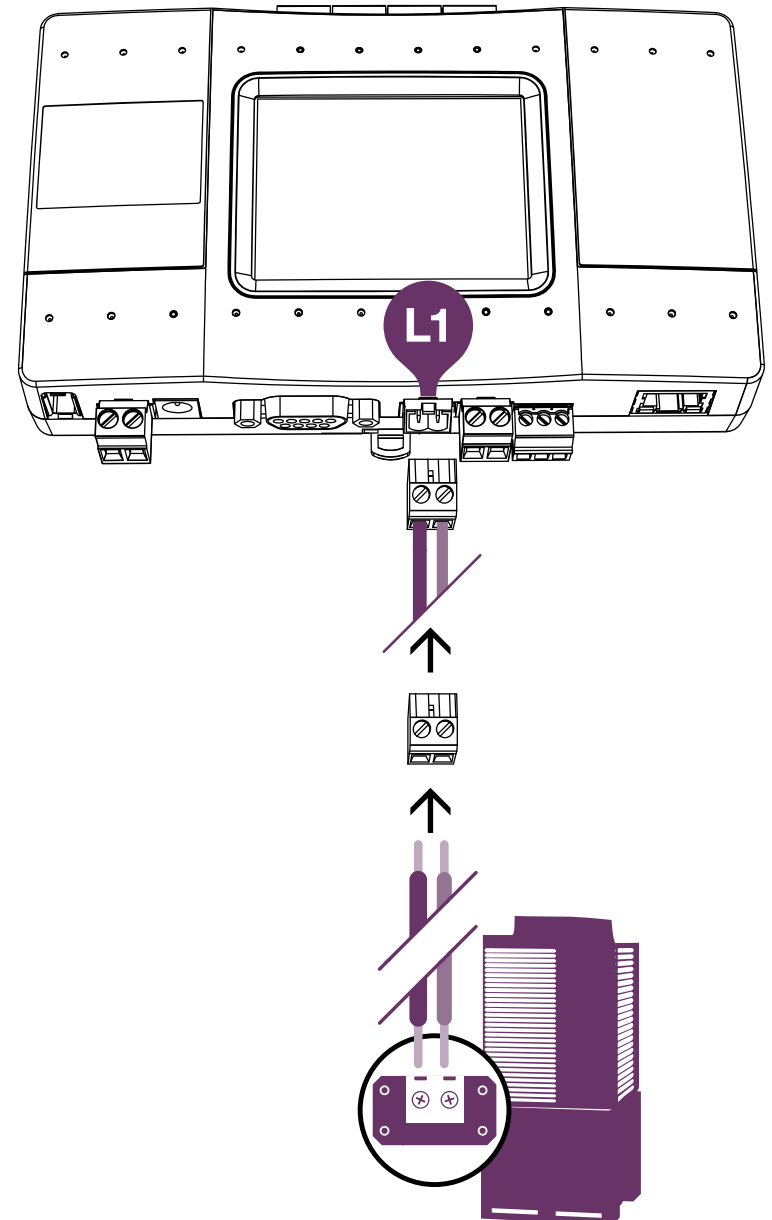
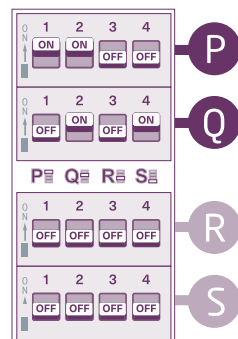
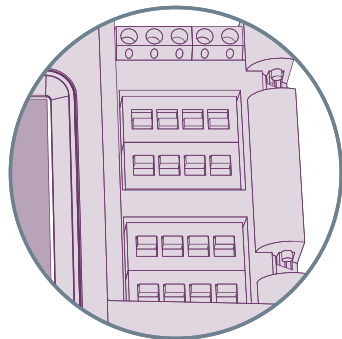

Hitachi HVAC Terminal

HVAC Haier VRF

1 HVAC Communication Terminals

HVAC outdoor connection



- * For Heat Recovery systems the connection is at outdoor units only.
- * Polarity is not required on the HVAC communication line.

2 Connecting to the line plug

Secure the cables in the L1 line plug.

3 Plugging to the TDS20065

Insert the plug in to the TDS20065 L1 socket.

4 Check DIP Switches are set correctly

Dip switches setup for VRF HVAC system on L1.

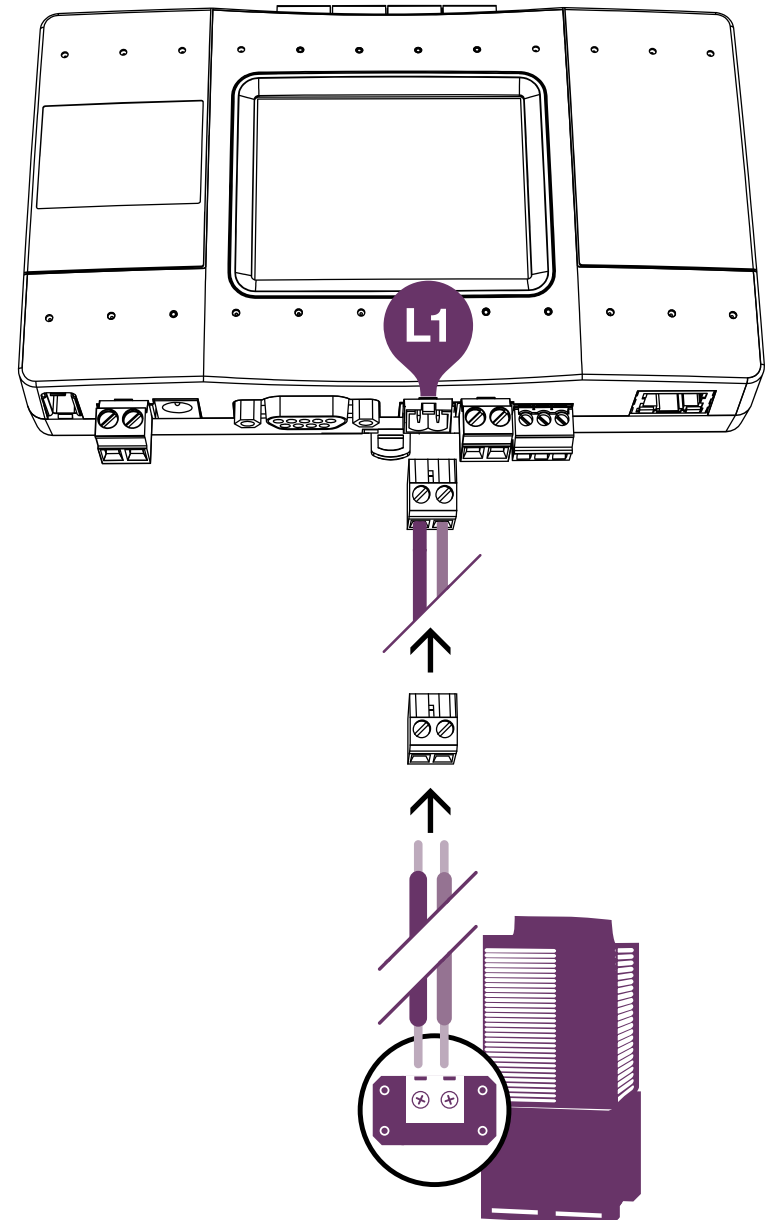
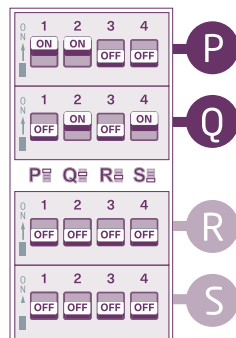
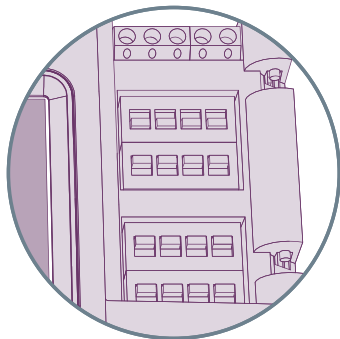

Haier HVAC Terminal

HVAC Mitsubishi Heavy VRF

1 HVAC Communication Terminals

HVAC outdoor connection



2 Connecting to the line plug

Secure the cables in the L7 line plug.

3 Plugging to the TDS20065

Insert the plug in to the TDS20065 L7 socket.

4 Check DIP Switches are set correctly

Dip switches setup for VRF HVAC system on L7.

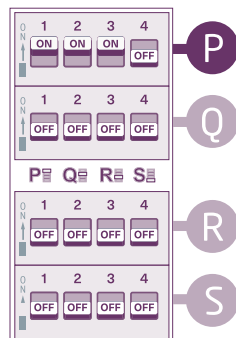
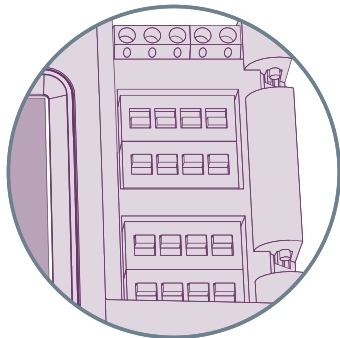

Mitsubishi Heavy HVAC Terminal

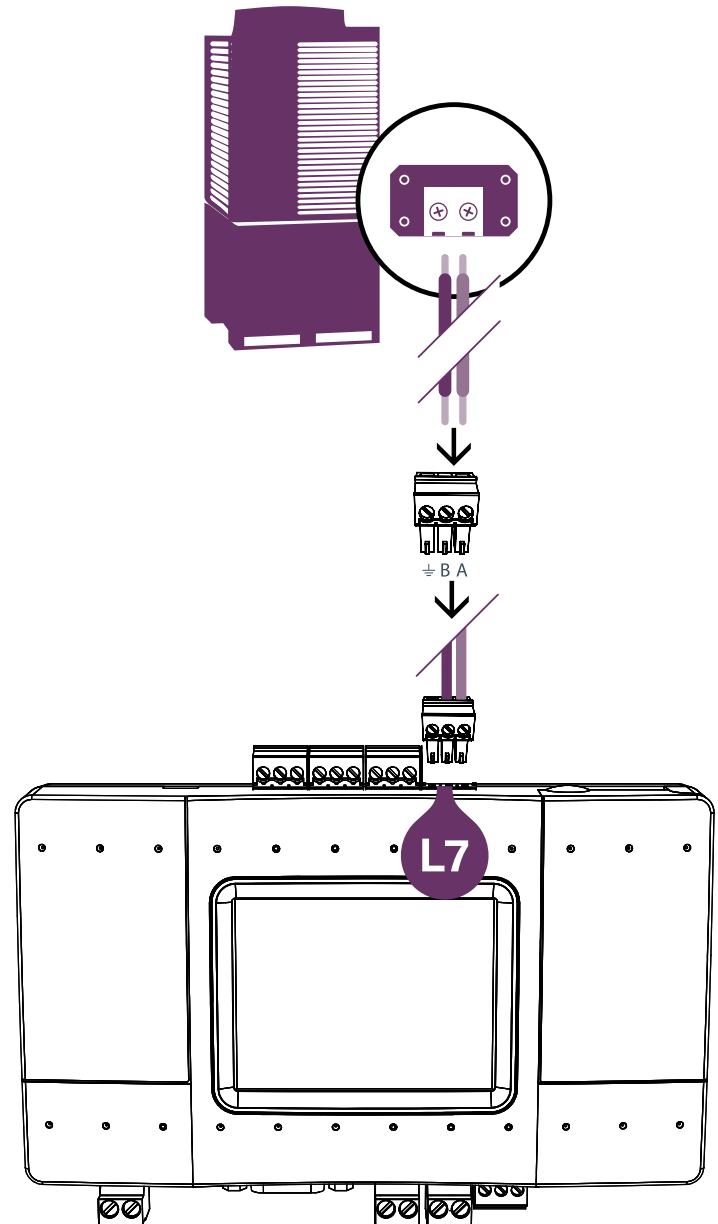

HVAC LG VRF

1 HVAC Communication Terminals

HVAC outdoor connection



2 Connecting to the line plug

Secure the cables in the L7 line plug.

3 Plugging to the TDS20065

Insert the plug in to the TDS20065 L7 socket.

4 Check DIP Switches are set correctly

Dip switches setup for VRF HVAC system on L7.

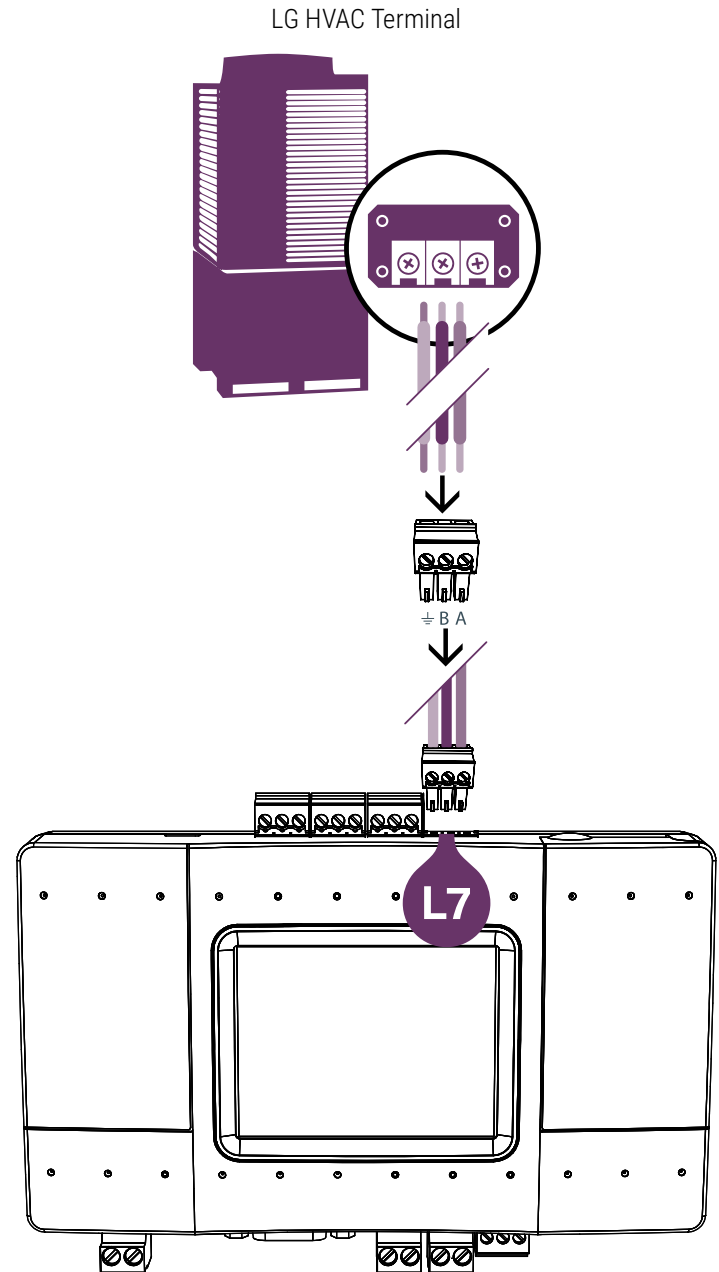
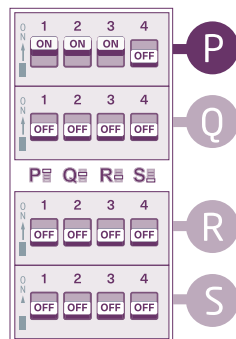
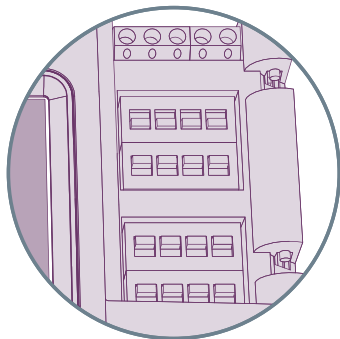

HVAC AUX VRF

① HVAC Communication Terminals

HVAC outdoor connection



② Connecting to the line plug

Secure the cables in the L7 line plug.

③ Plugging to the TDS20065

Insert the plug in to the TDS20065 L7 socket.

④ Check DIP Switches are set correctly

Dip switches setup for VRF HVAC system on L7.

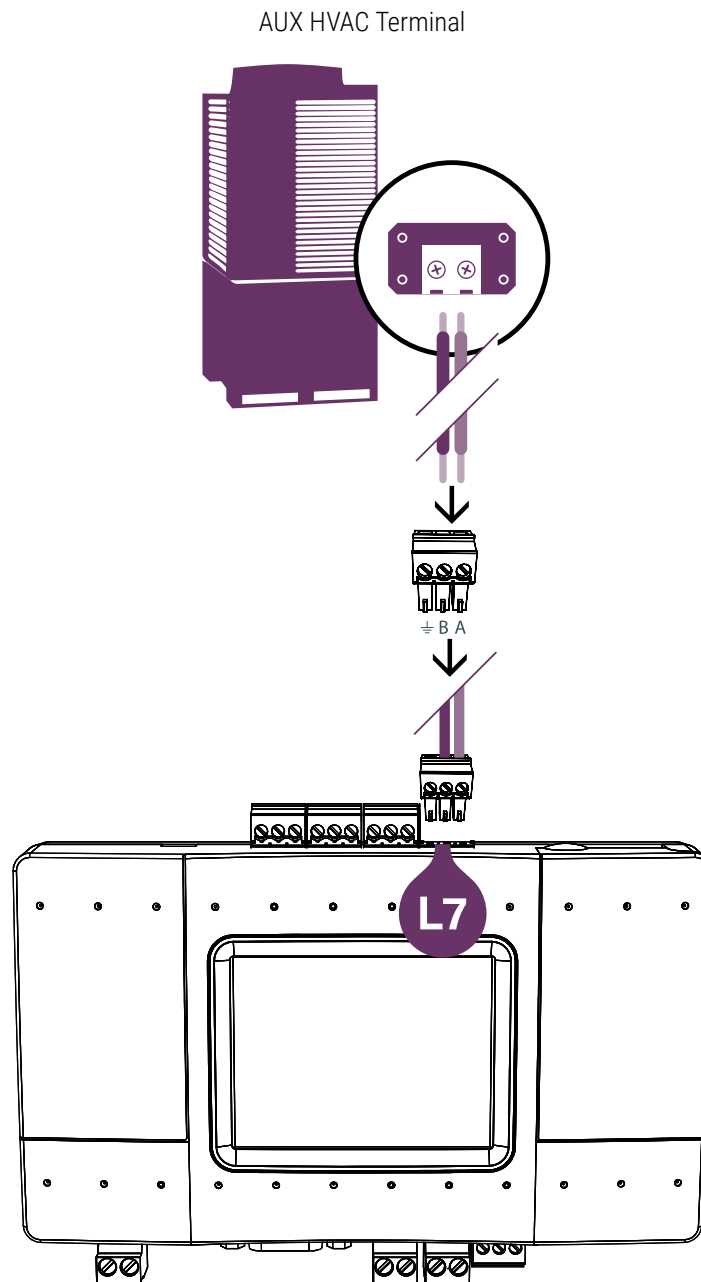
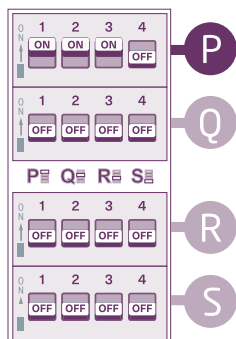
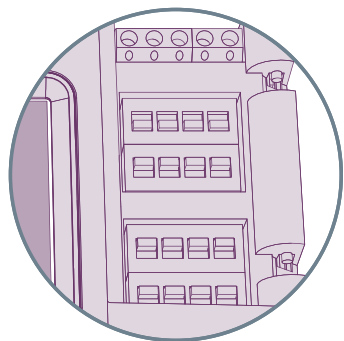

HVAC Gree/GMV4 VRF

1 HVAC Communication Terminals

HVAC outdoor connection

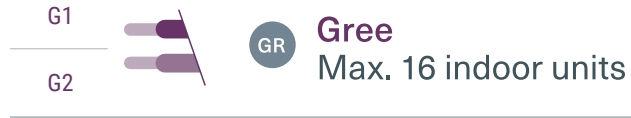

2 Connecting to the line plug

Secure the cables in the L7 line plug.

3 Plugging to the TDS20065

Insert the plug in to the TDS20065 L7 socket.

4 Check DIP Switches are set correctly

Dip switches setup for VRF HVAC system on L7.

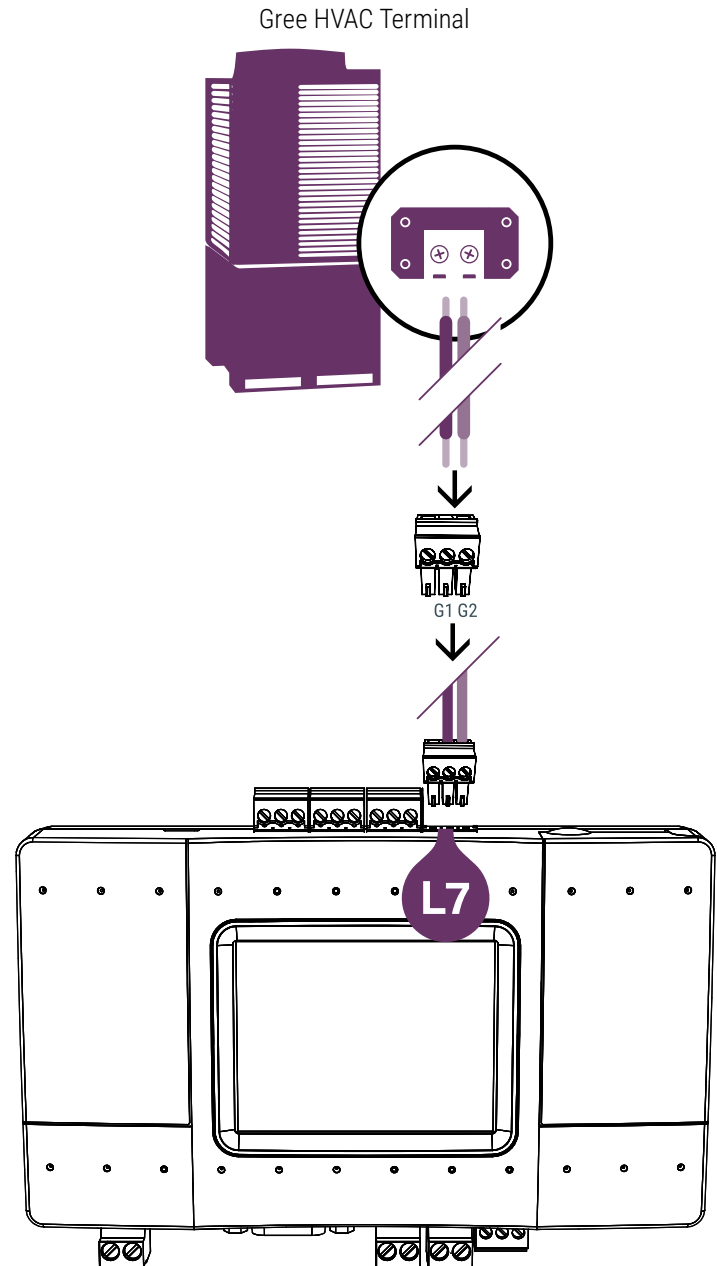
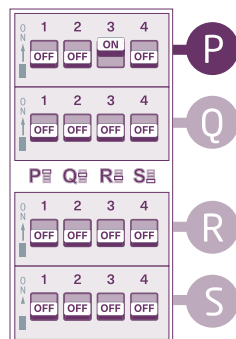
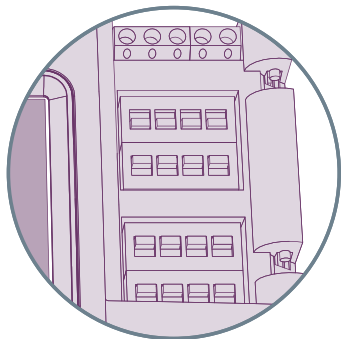

HVAC Midea VRF

1 HVAC Communication Terminals

HVAC outdoor connection



2 Connecting to the line plug

Secure the cables in the L7 line plug.

3 Plugging to the TDS20065

Insert the plug in to the TDS20065 L7 socket.

4 Check DIP Switches are set correctly

Dip switches setup for VRF HVAC system on L7.

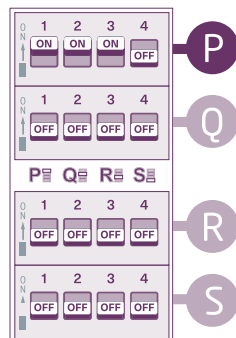
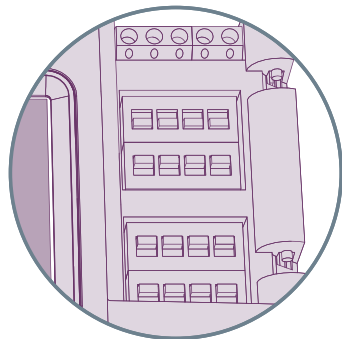

Midea HVAC Terminal

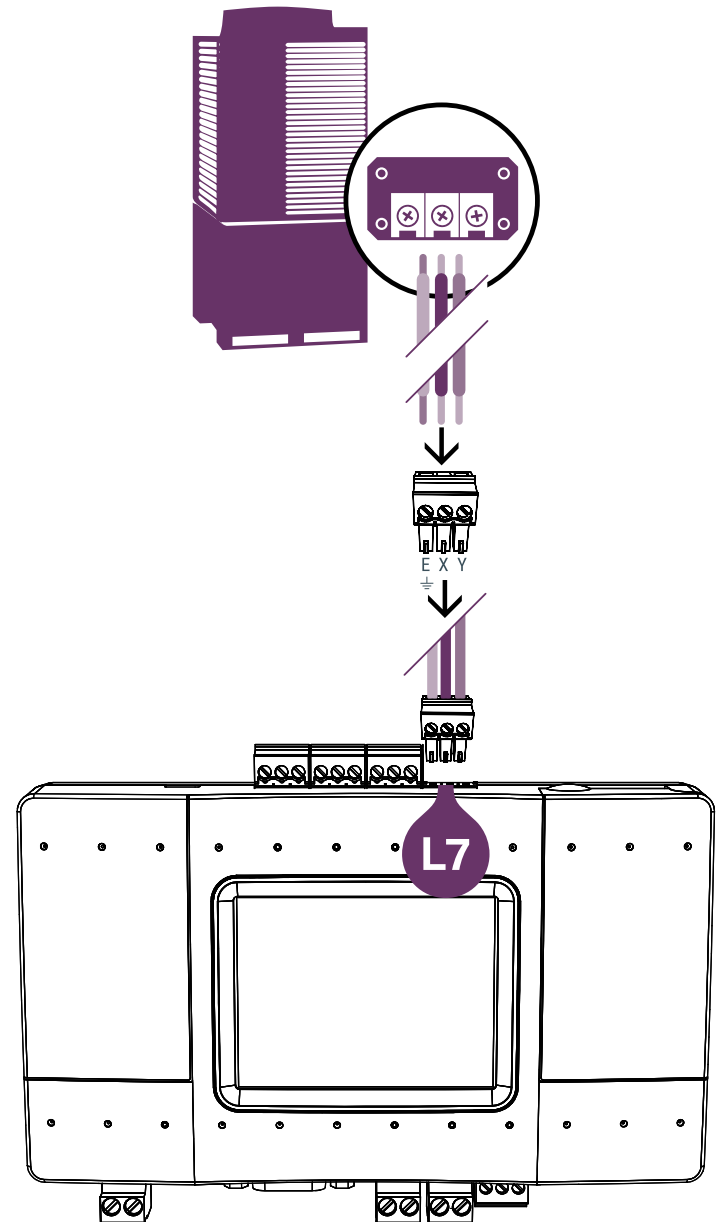

HVAC Samsung VRF

1 HVAC Communication Terminals

HVAC outdoor connection



2 Connecting to the line plug

Secure the cables in the L7 line plug.

3 Plugging to the TDS20065

Insert the plug in to the TDS20065 L7 socket.

4 Check DIP Switches are set correctly

Dip switches setup for VRF HVAC system on L7.

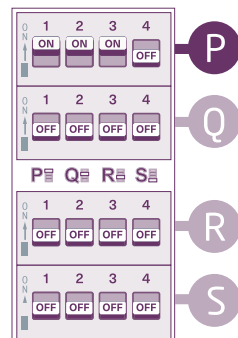
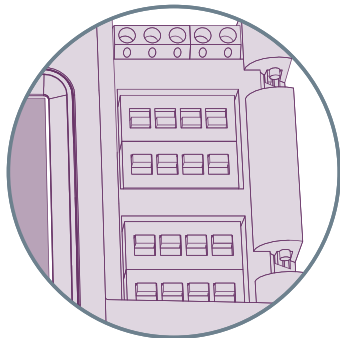

Samsung HVAC Terminal

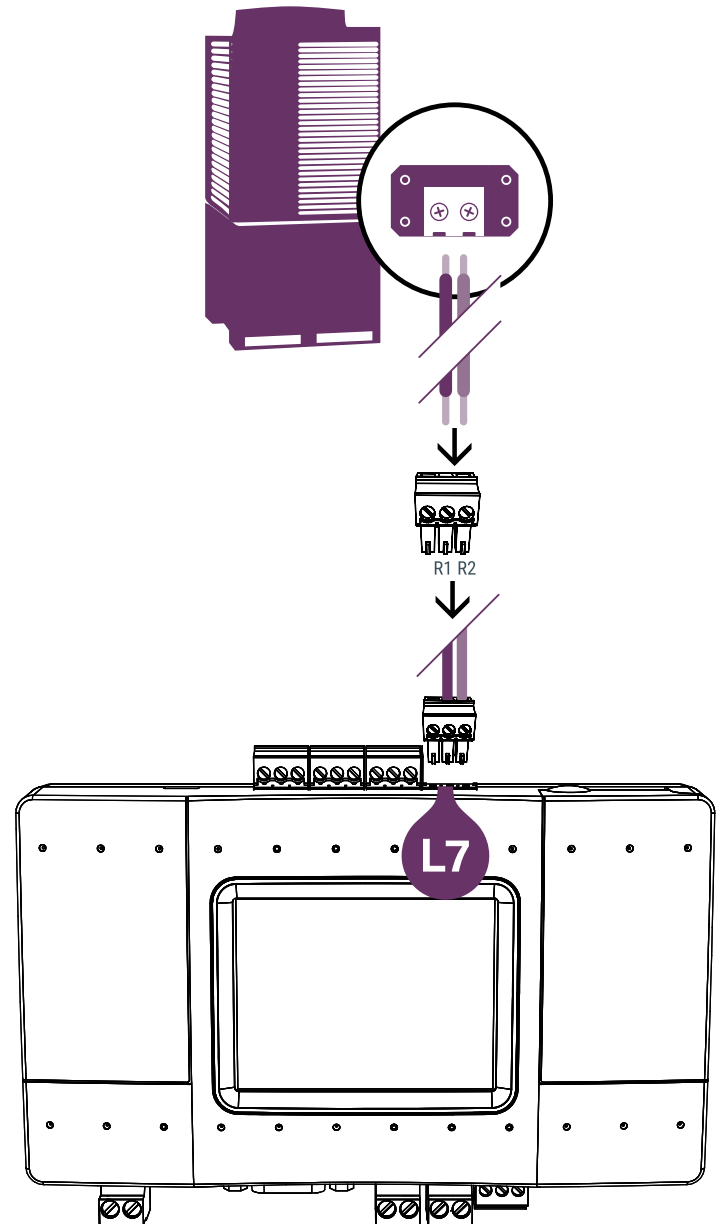

HVAC Chigo VRF

1 HVAC Communication Terminals

HVAC outdoor connection

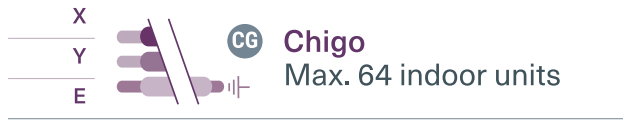

2 Connecting to the line plug

Secure the cables in the L7 line plug.

3 Plugging to the TDS20065

Insert the plug in to the TDS20065 L7 socket.

4 Check DIP Switches are set correctly

Dip switches setup for VRF HVAC system on L7.

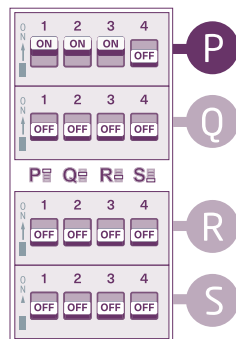
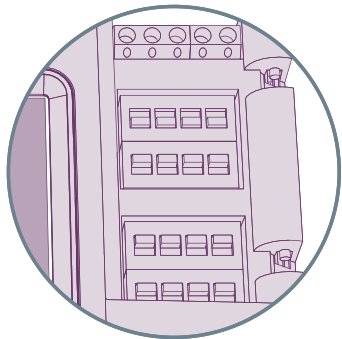

Chigo HVAC Terminal

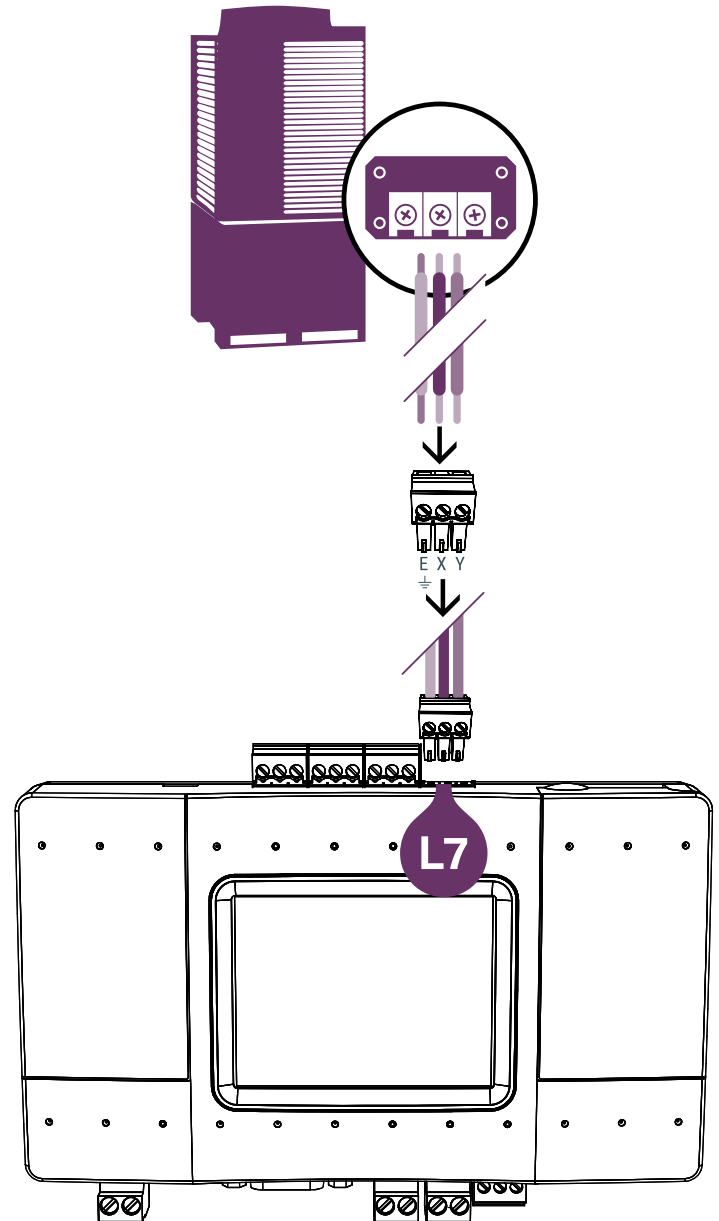

HVAC Blue Star VRF

1 HVAC Communication Terminals

HVAC outdoor connection



2 Connect DVRF Modbus Converter

Secure the cables from Outdoor in RS485

Secure cables in Output 3 / Modbus to CoolMasterNet.

3 Plugging to the TDS20065

Insert the plug in to the TDS20065 L7 socket.

4 Check DIP Switches are set correctly

Dip switches setup for VRF HVAC system on L7.

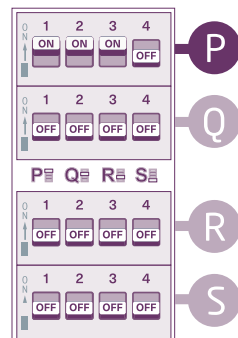
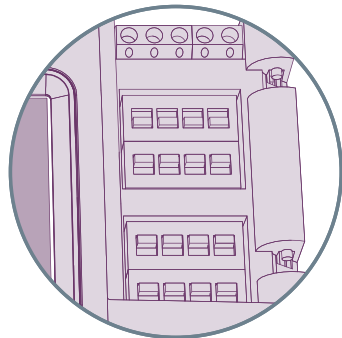

Blue Star HVAC Terminal

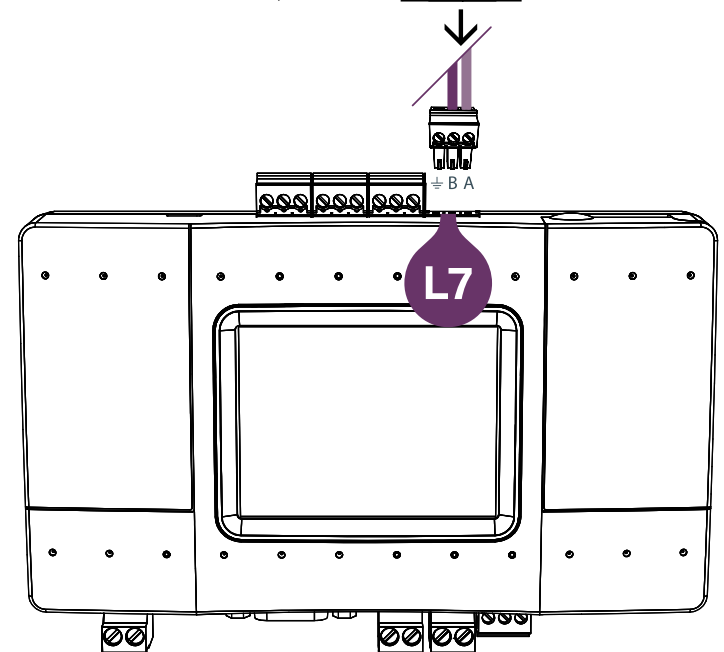
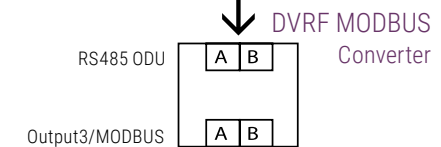
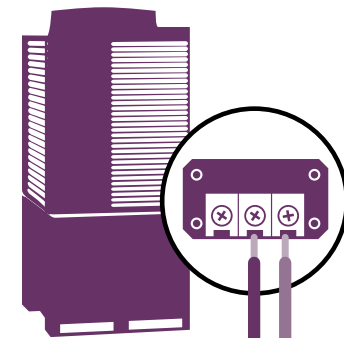

HVAC Gree GMV5, GMV6 VRF

1 HVAC Communication Terminals

HVAC outdoor connection

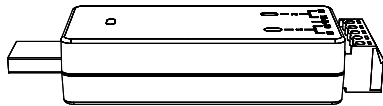

2 Connecting to the CMNET-GR-GMV5/6

USB Network Interface (CMNET-GR-GMV5/6) adapter is required for connecting up to two Gree GMV5/6 VRF lines.

(Contact TELETASK specialist for more information)

This adapter includes a CAN bus 120 Ω resistor.

3 Plugging to the TDS20065

Insert the plug in to the TDS20065 L8 (USB).

4 Check DIP Switches are set correctly

Dip switches setup for GMV5/6 VRF HVAC system on L8.

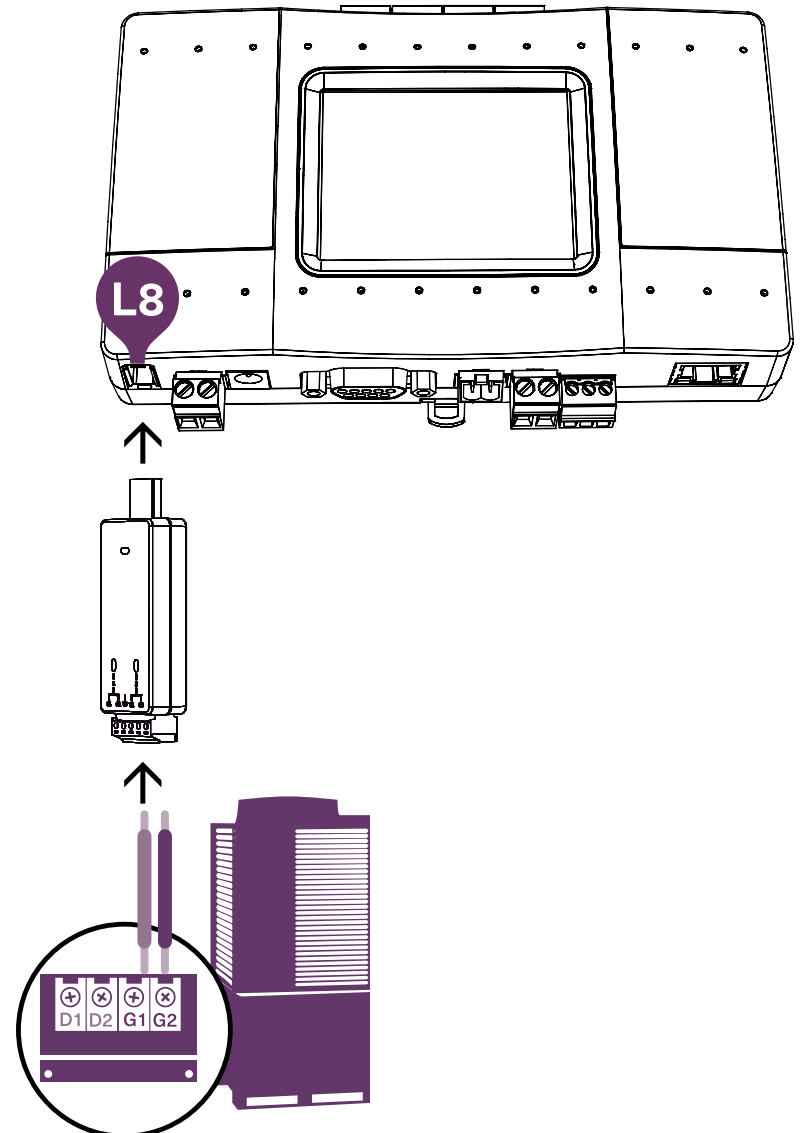
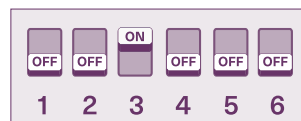
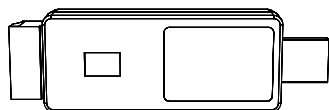

Gree GMV5/6 HVAC Terminal

HVAC Fujitsu VRF

① HVAC Communication Terminals

HVAC outdoor connection

Z1



Z2



Fujitsu
Max. 128 indoor units

② Connecting to the Echelon adapter

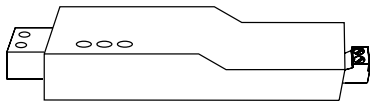

Adapter is required for connecting to Fujitsu (General) VRF. (Order separately as item TDS20066)

③ Connect Echelon via USB Extension cable

Connect the USB Extension cable (A-Male to A-Female) to the adapter TDS20066

④ Plug in to the TDS20065 L8

Insert the USB cable in to the L8 USB host.

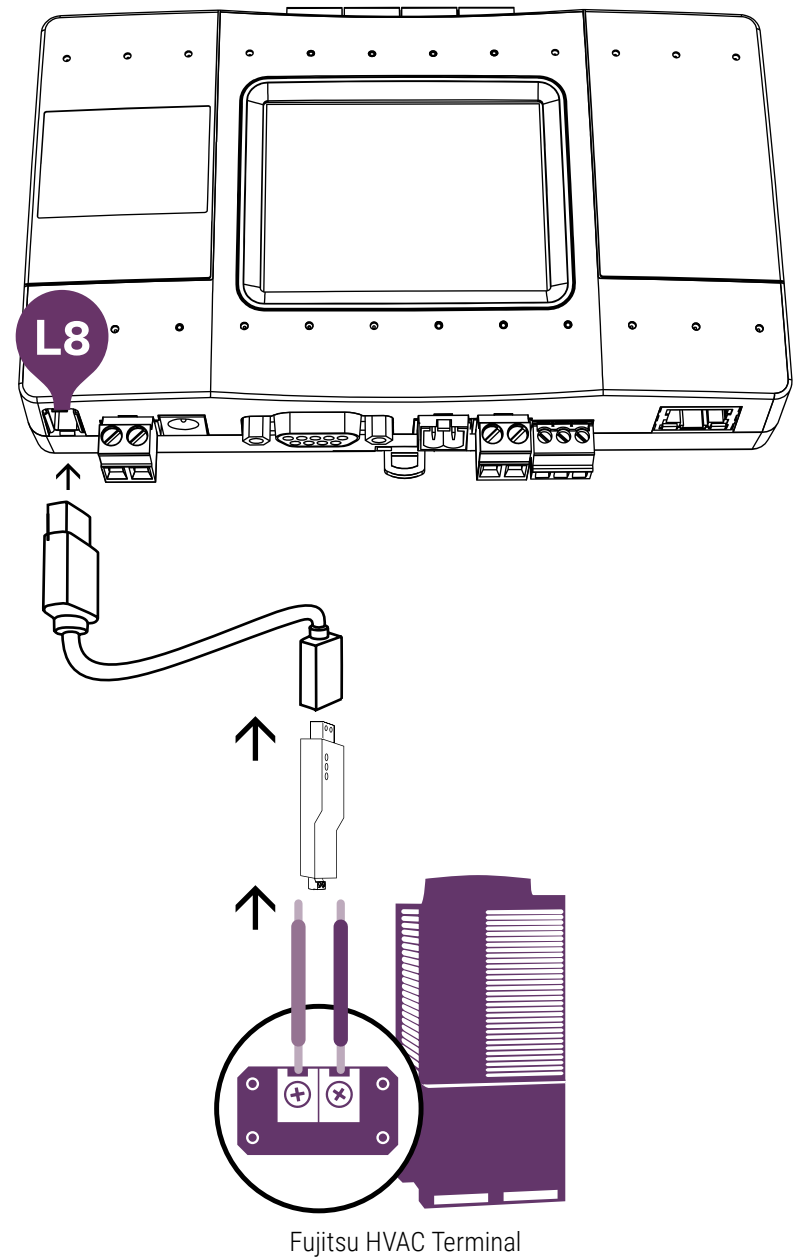

How to change the brand of a specific line

In order to change the HVAC brand type on a specific line, please follow the below procedure on TDS20065 screen:

1 Go to Settings

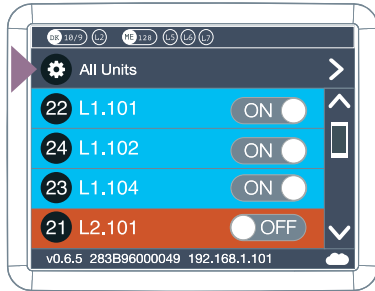

2 Go to HVAC Line

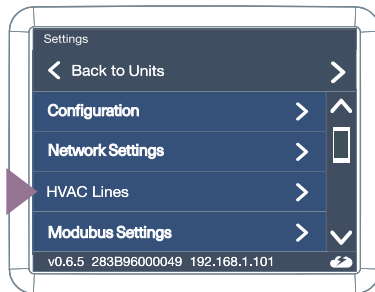

3 Select the HVAC Line you want to configure

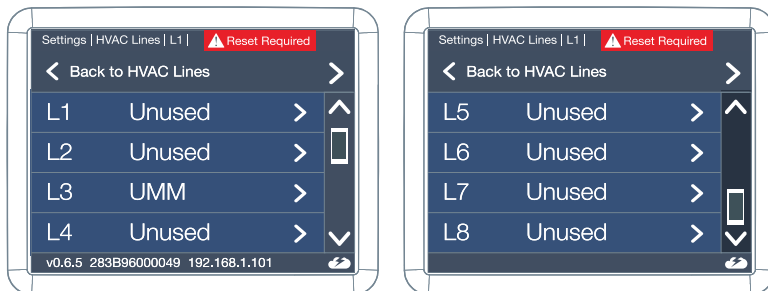

4 Configure the HVAC line type

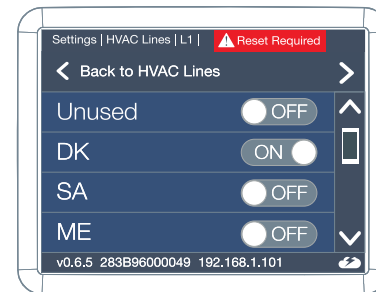
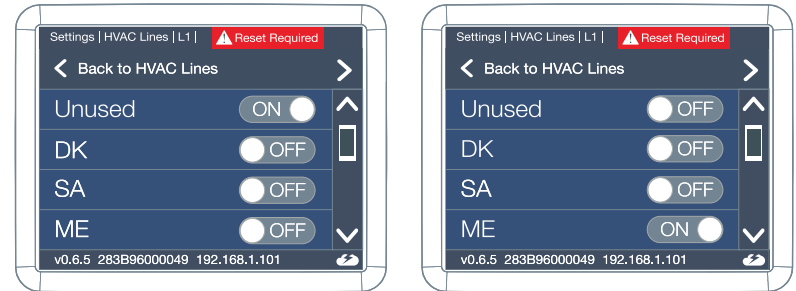

5 Make sure the DIP switches are set properly for the brand (according to the details in the brand relevant section above)



6 You will also have a red warning message if DIP switch are set incorrect

7 Reset is required to make the change

CoolMasterNet installation complete

TDS20065 Unit screen

After successful installation, unit's screen will show all the detected indoor units and their statuses.

- 1 Active HVAC line (DK 9/10) (Groups/Units)
 - 2 Inactive HVAC line
 - 3 All ON/OFF operation button
 - 4 Scrollbar
 - 5 Connected indoor unit with it's address and Set-Point temperature indication.
 - 6 Indoor unit operation button (on/off)
 - 7 Service settings button
 - 8 TDS20065 MAC address
 - 9 TDS20065 IP address
 - 10 CoolRemote connectivity status
-  Connected - Communicating
 -  Connected - Idle
 -  Disconnected - with error code

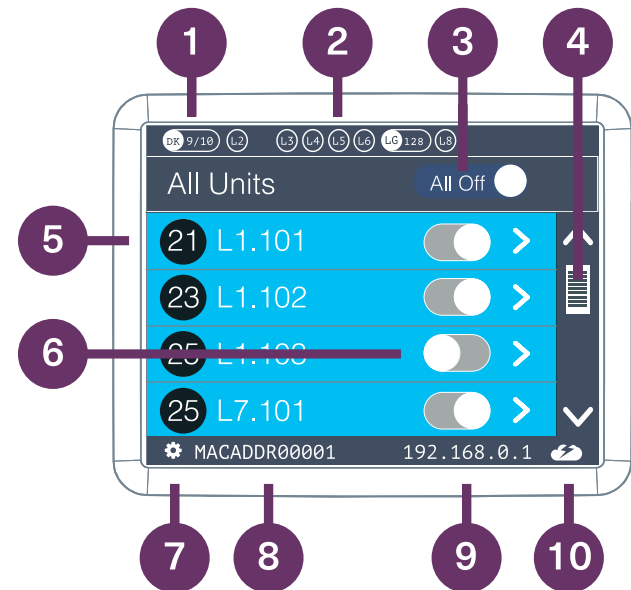

TELETASK Home Automation and TELETASK app

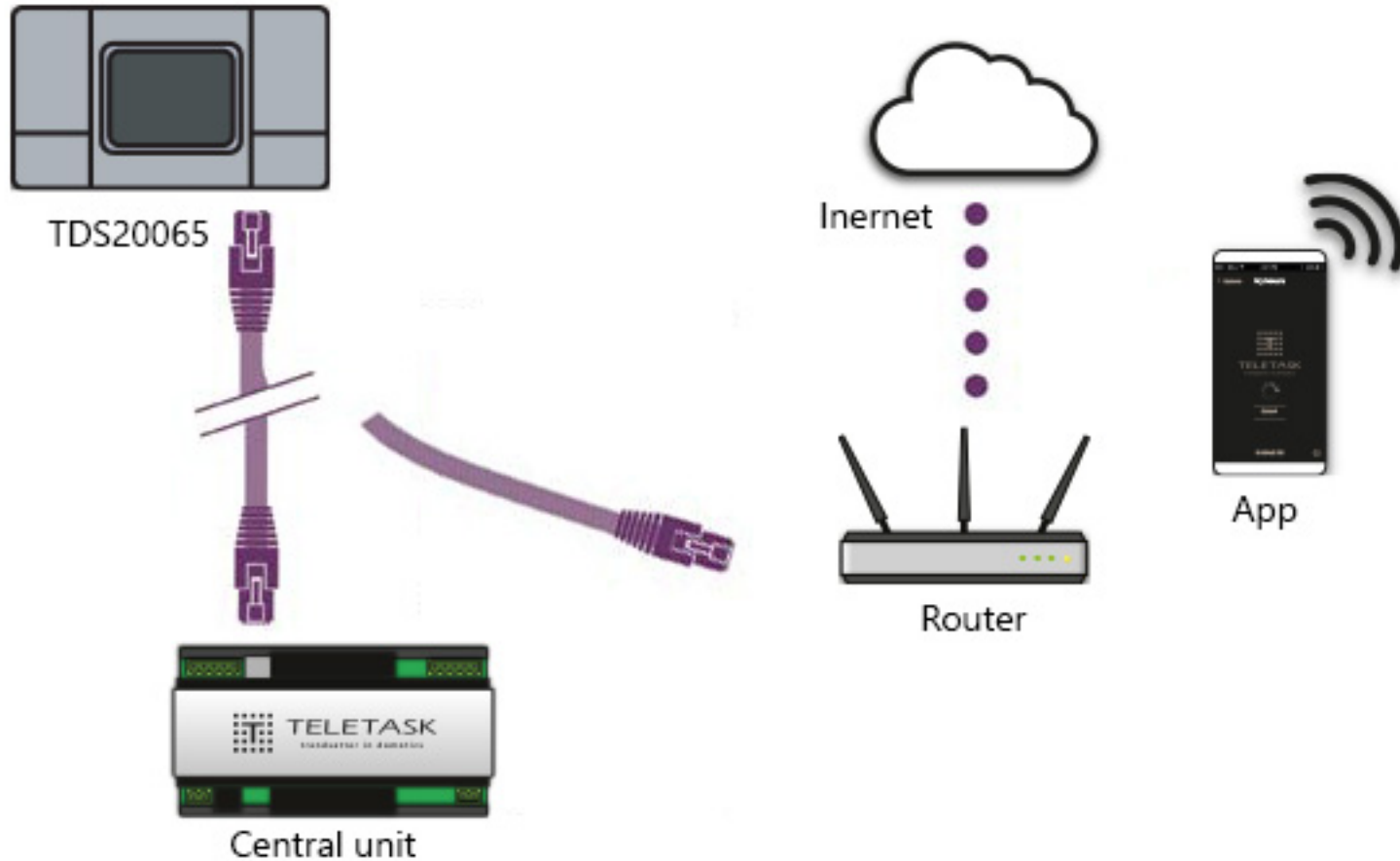

Power Supply

Option A

AC Power supply adapter
(Included in the Box)

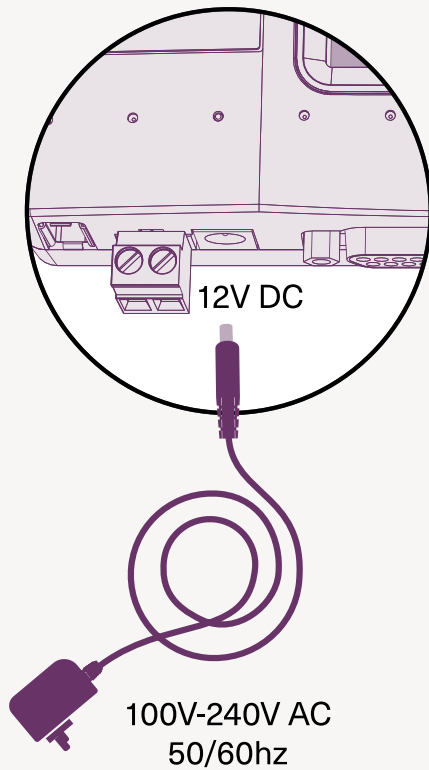

Option B

Direct DC power supply

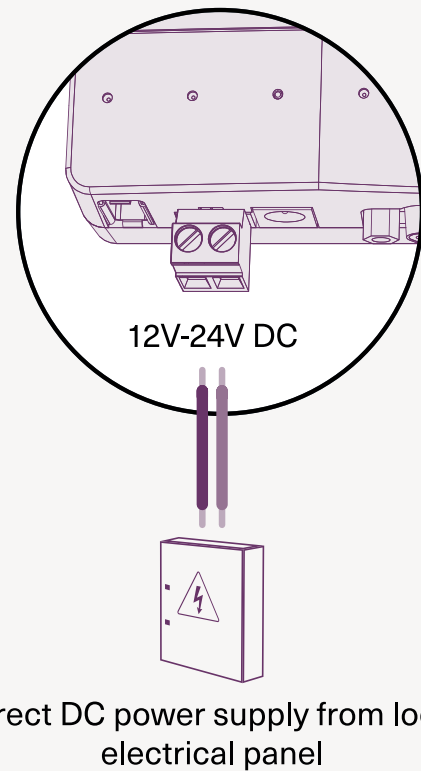

All On/Off operation by external signal

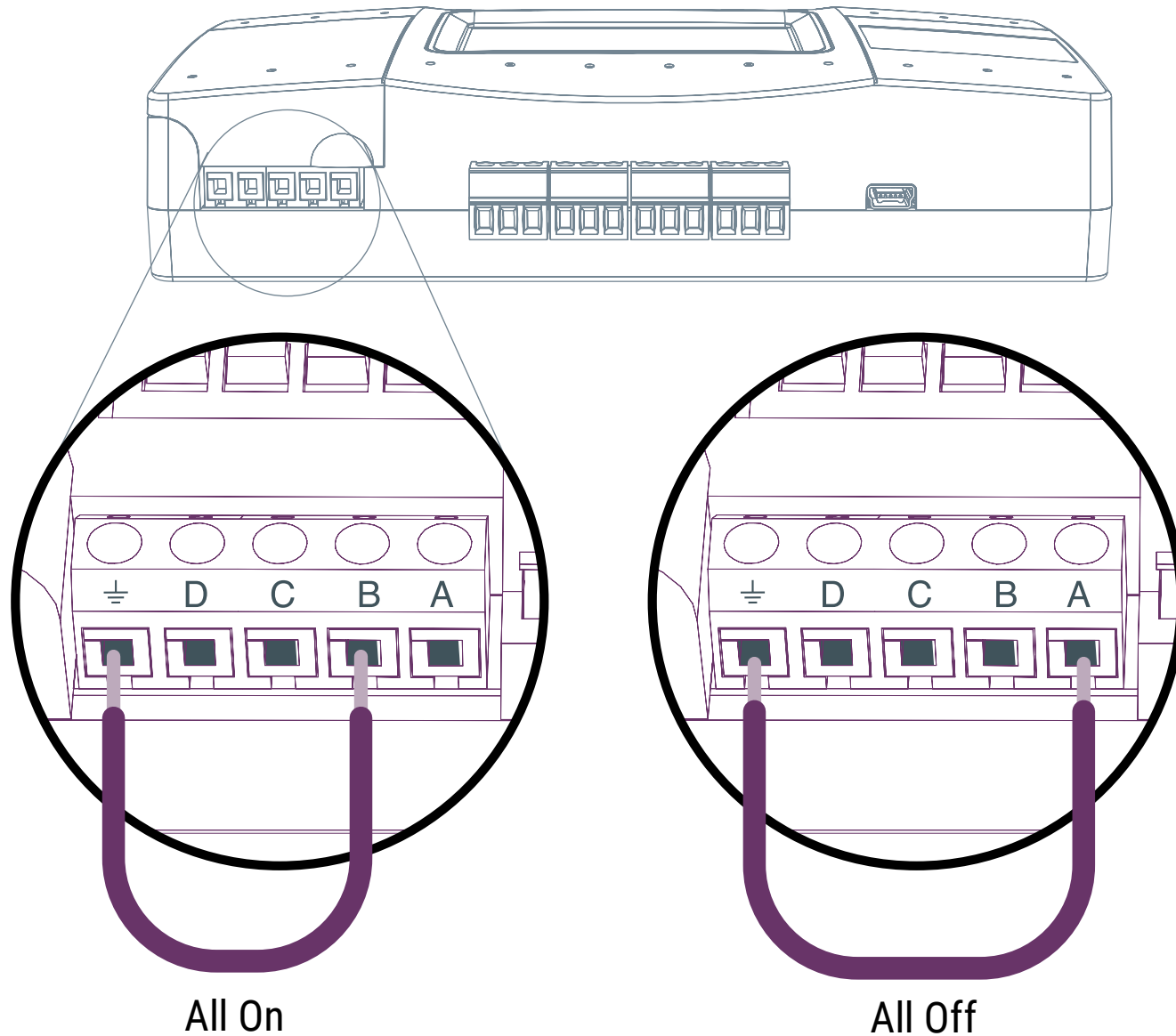

Mounting on a DIN rail

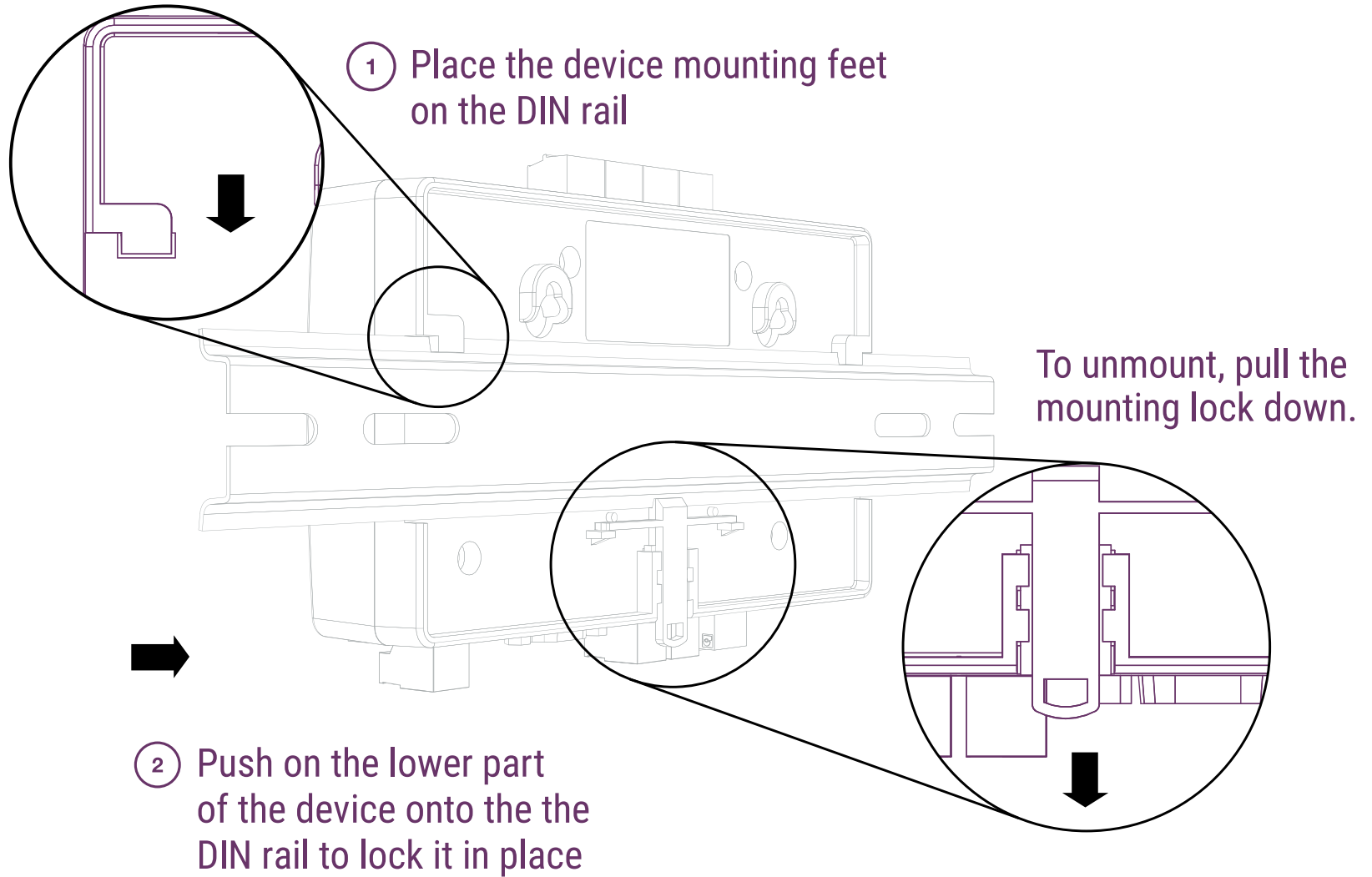

Mounting on a wall

For mounting the TDS20065 with wall screws, please see attached template with 1:1 dimensions.

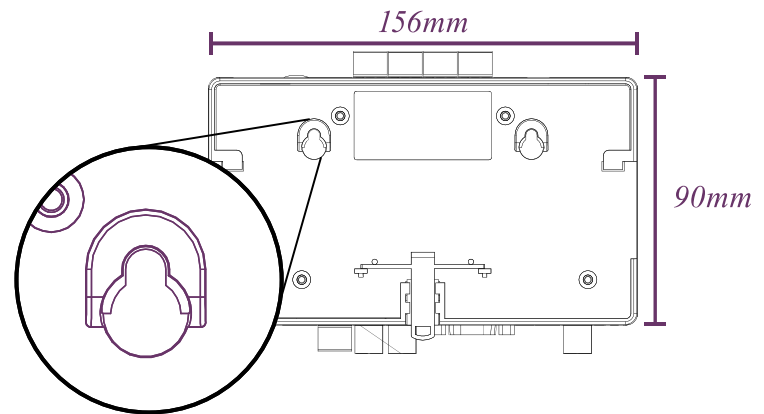

1:1 SCALE MOUNTING TEMPLATE FOR WALL SCREWS

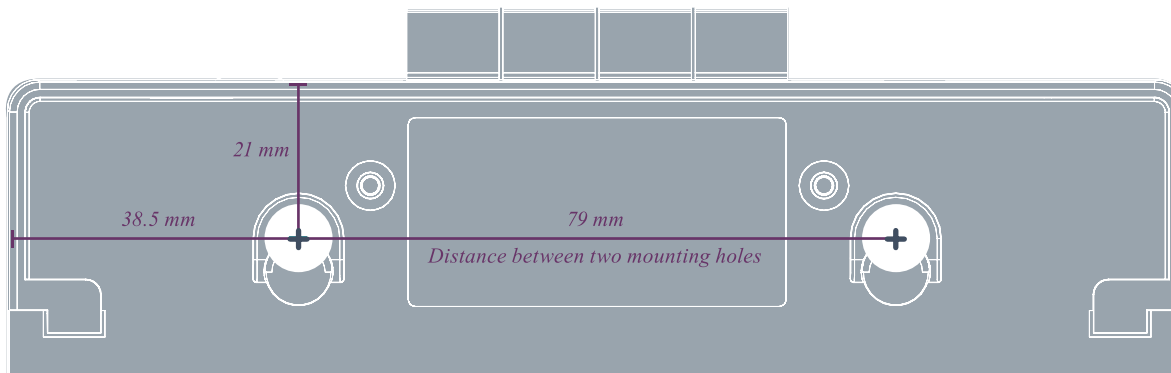

Online Documentation and Support

For complete installation guide go to TELETASK Professional:

<https://professional.teletask.be>

Or scan the QR code below



<https://professional.teletask.be/TDS20065+Universal+HVAC>

Need more help?

Contact you local supplier

<https://teletask.be/en/contact/>